

SKM 9000



Instruction manual

Contents

Important safety instructions	2
The SKM 9000 radio microphone	4
Delivery includes	4
Product overview	5
Preparing the SKM 9000 for use	7
Changing the microphone head	8
Using the SKM 9000	9
Switching the SKM 9000 on/off	10
Activating/deactivating the automatic lock mode (Autolock)	11
Basic functions of the Sennheiser operating menu	12
Overview of the status displays	13
Overview of the menu items	14
Cleaning and maintaining the SKM 9000	16
If a problem occurs	18
Specifications	19
System characteristics	19
Operating conditions	20
SKM 9000 characteristics	21

Important safety instructions

- Read this instruction manual.
- Keep this instruction manual. Always include this instruction manual when passing the product on to third parties.
- Heed all warnings and follow all instructions.
- Do not use the product near water.
- Only clean the product with a dry cloth.
- Do not place the product near any heat sources such as radiators, stoves, or other devices (including amplifiers) that produce heat.
- Only use attachments, accessories or spare parts specified by Sennheiser.
- Refer all servicing to qualified service personnel. Servicing is required if the product has been damaged in any way, liquid has been spilled, objects have fallen inside, the product has been exposed to rain or moisture, does not operate properly or has been dropped.
- **WARNING:** To reduce the risk of fire or electric shock, do not expose the product to rain or moisture.
- Do not expose the product to dripping or splashing.



Intended use

Intended use of the Digital 9000 system components includes:

- having read and understood this instruction manual, especially the chapter “Important safety instructions”,
- using the product within the operating conditions and limitations described in this instruction manual.

“Improper use” means using the product other than as described in this instruction manual, or under operating conditions which differ from those described herein.

This instruction manual is also available at www.sennheiser.com.

















Safety instructions for lithium-ion rechargeable batteries

If abused or misused, the rechargeable batteries may leak. In extreme cases, they may even present a risk of



- explosion,
- fire development,
- heat generation,
- smoke or gas development.

Sennheiser does not accept any liability for damage arising from abuse or misuse.

	Keep away from children.		Only charge rechargeable batteries with a charger recommended by Sennheiser.
	Observe correct polarity.		
	Do not expose to moisture.		Pack/store charged rechargeable batteries so that the terminals cannot contact each other – danger of shorting out/ fire hazard.
	Only charge rechargeable batteries at ambient temperatures between 10°C/50°F and 40°C/104°F.		
	Do not mutilate or dismantle.		Switch rechargeable battery-powered products off after use.
	Immediately remove rechargeable batteries from an obviously defective product.		When not using rechargeable batteries for extended periods of time, charge them regularly (about every three months).
	Do not continue to use defective rechargeable batteries.		
	Only use rechargeable batteries specified by Sennheiser.		Do not heat above 70°C/ 158°F, e.g. do not expose to sunlight or throw into a fire.
	Remove the rechargeable batteries if the product will not be used for extended periods of time.		
	Store the product in a cool and dry place at room temperature (approx. 20 °C/68 °F).		Dispose of rechargeable batteries at special collection points or return them to your specialist dealer.

The SKM 9000 radio microphone

The SKM 9000 radio microphone offers great ease of use and can easily be adapted to any transmission situation:

- Rugged housing
- Input gain adjustable in 3 dB steps
- Switchable 1 kHz test tone, useful for level matching the system and for the walk test
- Detection and support of the type of microphone head being used, incl. Neumann microphone heads
- High accuracy of charge status display (BA 60) or remaining operating time display (B 60)
- Switchable low cut filter for filtering out low frequency components
- Frequencies tuneable in 25 kHz steps
- Power supply optionally via BA 60 lithium-ion accupack or B 60 battery pack (2 AA size alkaline batteries or 2 AA size lithium batteries)
- Different microphone heads for different areas of application (see page 6)
- Optionally available with command function

Delivery includes

- 1 SKM 9000 or SKM 9000 COM radio microphone
- 1 MZQ 9000 microphone clamp
- 1 supplement "Framework requirements and restrictions on frequency usage"
- 1 instruction manual







You additionally require microphone heads as well as a BA 60 accupack and/or a B 60 battery pack.

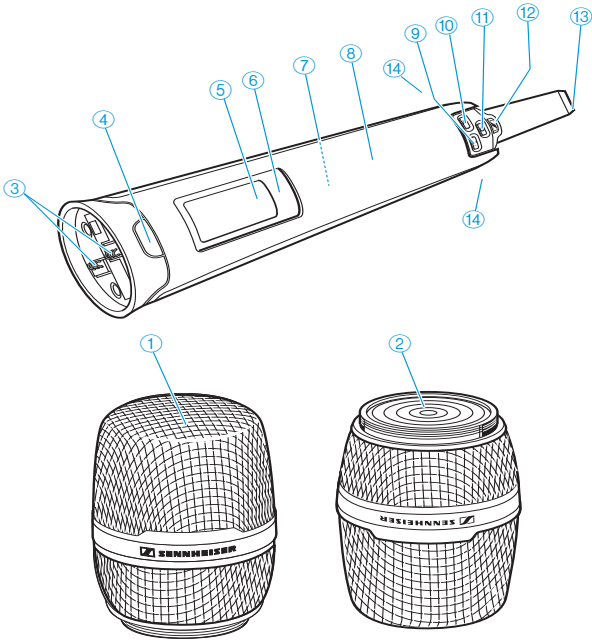

A list of accessories can be found on the Digital 9000 product page at www.sennheiser.com.
For information on suppliers, contact your local Sennheiser partner: www.sennheiser.com > "Service & Support".

Product overview



- | | |
|---|--|
| <ul style="list-style-type: none"> ① Microphone head ② Contact rings of microphone head ③ Contacts of radio microphone ④ COMMAND button (COM version only)* ⑤ Display panel ⑥ Infra-red interface ⑦ Accupack or battery pack for 2 AA size cells ⑧ Body of radio microphone | <ul style="list-style-type: none"> ⑨ DOWN button  ⑩ UP button  ⑪ SET button  ON/OFF button  with ESC function (cancel):
- lights up constantly:
radio microphone is operational ⑫ Antenna ⑬ Catches for accupack/battery pack |
|---|--|



The COMMAND button can be configured via the operating menu of the EM 9046 receiver (see "Cmd mode – Configuring the audio and command outputs" in the the system instruction manual).

Overview of the standard display after switch-on

After switch-on, the radio microphone displays the following standard display.

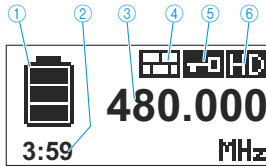

- ① Display for charge status of the accupack/battery pack
- ② Operating time display (only when used with the BA 60)
- ③ Frequency/channel/name display, switchable
- ④ “Encryption” display
- ⑤ Lock mode icon
- ⑥ Transmission mode display: “HD” (High Definition Audio) or “LR” (Long Range Audio)

Recommended microphone heads

Microphone head	Pick-up pattern	Transducer principle
ME 9002	omni-directional	condenser
ME 9004	cardioid	condenser
ME 9005	super-cardioid	condenser
MD 9235	super-cardioid	dynamic
MMD 935-1	cardioid	dynamic
MMD 945-1	super-cardioid	dynamic
MMK 965-1	cardioid/super-cardioid, switchable	permanently polarized
KK 204 (Neumann)	cardioid	condenser
KK 205 (Neumann)	super-cardioid	condenser



You can also use your radio microphone together with the microphone heads of the ew G3 and 2000 series.

Preparing the SKM 9000 for use

Selecting the accupack/battery pack

You can power the SKM 9000 radio microphone using:

- the BA 60 accupack
- the B 60 battery pack for two 1.5 V AA size batteries

i Charge the BA 60 accupack before using it for the first time (see the instruction manual for the Digital 9000 system).

CAUTION!

Damage to the radio microphone and/or the accupack/battery pack

If you touch the following contacts, they can become dirty or damaged:

- Charging and data contacts of the BA 60 accupack
 - Data contacts of the B 60 battery pack
- ▶ Do not touch the contacts of the BA 60 accupack nor the contacts of the B 60 battery pack.

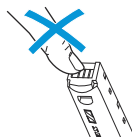

Inserting batteries into the B 60 battery pack

- ▶ Insert the batteries into the battery pack (see diagram). Observe correct polarity when inserting the batteries.

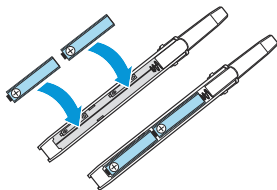

i Only insert high-quality AA size batteries (e.g. lithium or alkaline batteries) into the B 60 battery pack. If you insert rechargeable batteries, the charge status display ⓘ will show a wrong value.

Removing and attaching the accupack/battery pack

To **remove** the accupack/battery pack:

- ▶ Push the two catches ⑭ and pull the accupack/battery pack out of the radio microphone's body (see diagram 1).

i When removing the accupack/battery pack, the settings of the radio microphone are retained.

To **attach** the accupack/battery pack:

- ▶ Push the accupack/battery pack into the radio microphone's body until it locks into place with an audible click (see diagram 2).

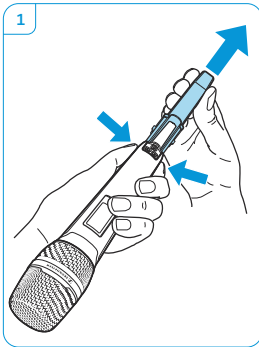

Changing the microphone head

CAUTION!

Damage to the microphone head!

If you touch contacts, they can become dirty or damaged.

- ▶ Do not touch the contacts ③ of the radio microphone nor the contact rings ② of the microphone head.

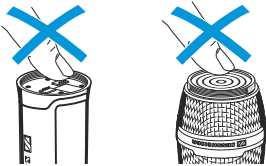

- ▶ Unscrew the microphone head ①.

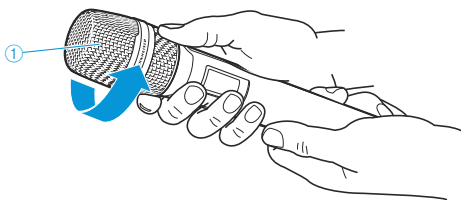

i With some microphone heads, the upper part of the sound inlet basket can be unscrewed. To fully unscrew the microphone head, always hold it as shown.

For an overview of suitable microphone heads, refer to the table on page 6.

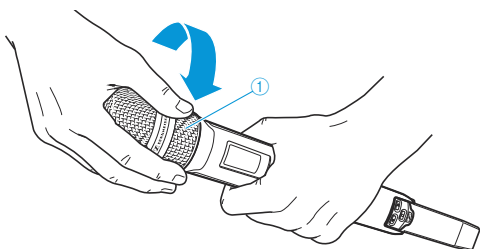

► Screw the desired microphone head to the radio microphone. The radio microphone is operational again.

i When unscrewing the microphone head ① during operation, the muting function is automatically activated.

Using the SKM 9000

i **Before** using your radio microphone, ask the relevant wireless regulatory authority for the exact frequency allocations and apply for an individual license if necessary.

The supplied supplement “Framework requirements and restrictions on frequency usage” provides an overview of the different European framework requirements and restrictions on frequency usage. If there is no entry in the supplement, ask the relevant wireless regulatory authority for the current rules governing frequency usage.

i We recommend you to adjust the transmitter settings via the operating menu of the EM 9046 receiver and then to synchronize the transmitter and the receiver.

Switching the SKM 9000 on/off

To switch the SKM 9000 **on**:

- ▶ Keep the **ON/OFF** button  ⑫ pressed until the Sennheiser logo appears on the display panel ⑤.



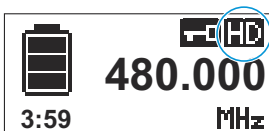
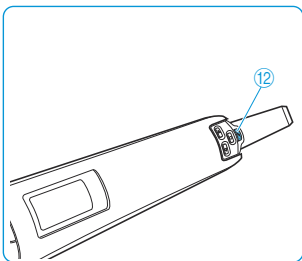

The **ON/OFF** button  ⑫ is backlit in blue and the selected standard display (here: "Frequency", see page 15) appears on the display panel ⑤. The radio microphone transmits an RF signal and the transmission mode display "HD"/"LR" lights up constantly:



To switch the SKM 9000 **off**:

- ▶ Keep the **ON/OFF** button  ⑫ pressed until the display panel goes off.
- ▶ Remove the accupack/battery pack when the radio microphone will not be used for extended periods of time (see page 8).

To switch the SKM 9000 **off** with **the lock mode activated**:

- ▶ Press the **ON/OFF** button  ⑫ while the standard display is shown.
"LOCK" appears on the display panel because the lock mode is activated.
- ▶ Press the **UP** button  ⑩ or the **DOWN** button  ⑨.
- ▶ Press the **SET** button  ⑪.
The lock mode is temporarily deactivated, the lock mode icon ⑤ flashes.
- ▶ Within the next 2 seconds, press the **ON/OFF** button  ⑫ and keep it pressed until the display panel goes off.

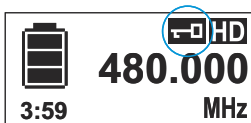



If you switch on the SKM 9000, the lock mode is activated again.

Switching on the SKM 9000 on and checking the set frequency before the RF signal is activated

- ▶ Switch on the SKM 9000 by keeping the **ON/OFF** button  ⑫ pressed until the “Name” standard display appears. The RF signal is not activated and the transmission mode display “HD”/“LR” ⑥ flashes.

If you call up the “Tune” or “Preset” menu item within the next 10 seconds, the RF signal remains deactivated until you exit the menu item. If you do not call up one of the mentioned menu items, the RF signal is automatically activated after 10 seconds.

To check the set frequency/the selected frequency preset:

- ▶ Call up the operating menu and press the **UP** button  ⑩/**DOWN** button  ⑨ until the “Tune” or “Preset” menu item appears. The set frequency/the selected frequency preset is displayed.

If the displayed value is the desired one:

- ▶ Wait for 10 seconds to pass. The RF signal is automatically activated and the transmission mode display “HD”/“LR” lights up constantly.

If the displayed value is **not** the desired one:



- ▶ Call up the “Tune” or “Preset” menu item. The RF signal remains deactivated until you exit the menu item.
- ▶ Set the frequency (menu item “Tune”) or select a frequency preset (menu item “Preset”) and store your setting. The RF signal is activated and the radio microphone transmits an RF signal on the set frequency.

Activating/deactivating the automatic lock mode (Autolock)

The radio microphone has an automatic lock mode that can be activated or deactivated via the “LOCK” menu item (see page 15).

To **permanently** activate the automatic lock mode:

- ▶ Call up the “LOCK” menu item and select “On”.
- ▶ Store your setting by pressing the **SET** button  ⑪. The automatic lock mode is activated and the lock mode icon ⑤ appears on the standard display.

When the automatic lock mode is activated, you can still call up the operating menu and use the **UP** button  ⑩/**DOWN** button  ⑨ to select menu items (read-only function). You can also call up the “LOCK” menu item in order to deactivate the automatic lock mode. If, however, you try to call up any other menu item, the following display appears on the display panel:



While this display is shown (about 2 seconds), you can temporarily deactivate the lock mode:

- ▶ Press the UP button  ⑩ or the DOWN button  ⑨.
- The following display appears on the display panel:



- ▶ Press the SET button  ⑪.
- The lock mode is temporarily deactivated.
- If you do not press a button, the lock mode is activated again after 2 seconds. The lock mode icon ⑤ lights up constantly again.
 - If you continue navigating the operating menu or if you call up a menu item, the lock mode is activated 2 seconds after the last button press.
 - If you exit a called up menu item, the lock mode is activated immediately after exiting the menu item.









To permanently deactivate the automatic lock mode:



- ▶ Call up the "LOCK" menu item and select "Off".
 - ▶ Store your setting by pressing the SET button  ⑪.
- The automatic lock mode is permanently deactivated. The lock mode icon ⑤ goes off

Basic functions of the Sennheiser operating menu







A special feature of the Sennheiser 9000 series is the straightforward, intuitive operating concept. As a result, you can act quickly and precisely – even in stressful situations, for example on stage or during a live show or presentation.

Calling up and selecting menu items, changing and storing settings, cancelling an entry











Button	Operation
UP  / DOWN  / SET 	<ul style="list-style-type: none"> ▶ Press the SET button  to call up the operating menu or a menu item, to switch between the selection areas of a menu item and to store your settings. ▶ Press the UP button / DOWN button  to select menu items and to change the settings of a menu item.
ON/OFF 	▶ Press the ON/OFF button  to exit a menu item without storing your settings or to change from the operating menu to the standard display.

 When keeping the **UP** button / **DOWN** button  pressed within a menu item, you continuously adjust the next/previous setting of the menu item. Keep the buttons pressed for a longer time to accelerate the speed.

Overview of the status displays

Status display	Meaning
	SKM 9000 switches on
	SKM 9000 switches off
	BA/B 60 accupack/battery pack: charge status $\leq 100\%$ $\leq 70\%$ $\leq 30\%$ BA 60 accupack: remaining operating time in h:mm
	Accupack/battery pack is completely discharged, transmitter is not operational
	Setting is being stored
	Firmware is being updated
	Firmware update has failed

Overview of the menu items

Icon	Name	Function	Page
	Tune	Sets a frequency	14
	Preset	Selects a frequency preset	14
	Name	Enters a name	15
	Gain	Adjusts the input gain	15
	Low cut	Sets the low-cut filter	15
	RF mode	Adjusts the transmission mode	15
	Display	Selects a standard display	15
	Lock	Activates/deactivates the lock mode	15
	Test tone	Activates the test tone for level matching the system and for the walk test	16
	Reset	Resets the factory default settings	16
	Information	Displays the firmware version and frequency range	16

“Tune” – Setting a frequency

Via the “Tune” menu item, you can set a frequency. The frequencies are tuneable in 25 kHz steps. If you store your setting, the set frequency is automatically assigned to the user-defined frequency preset “U”. The radio microphone then changes from the currently set frequency preset to the frequency preset “U” and transmits on the set frequency.

“Preset” – Selecting a frequency preset

Via the “Preset” menu item, you can select a frequency preset from the active booster frequency range or the frequency preset “U” (see also the “Tune” menu item).



To activate a different booster frequency range:

- ▶ Proceed as described in the instruction manual for the Digital 9000 system. You first activate the booster frequency range on the EM 9046. If you then synchronize the transmitter and the receiver, the booster frequency range on the transmitter will also be activated.

“Name” – Entering a name

Via the “Name” menu item, you can enter a freely selectable name for the radio microphone. The name can consist of up to 6 characters from the following character set:

```
+ ` , ` ; ` - ` | ` / ` 0 ` 1 ` 2 ` 3 ` 4 ` 5 ` 6 ` 7 ` 8 ` 9 ` * ` ; ` < ` = ` > `
`space` `#` `A` `B` `C` `D` `E` `F` `G` `H` `I` `J` `K` `L` `M` `N` `O` `P`
`Q` `R` `S` `T` `U` `V` `W` `X` `Y` `Z`
```

“Gain” – Adjusting the input gain

Via the “Gain” menu item, you can adjust the input gain in 3 dB steps.



The radio microphone automatically detects the type of microphone head being used and changes the adjustment range of the “Gain” menu item accordingly.

“Low cut” – Setting the low-cut filter

Via the “Low cut” menu item, you can set the low-cut filter. Settings: “80 Hz”, “100 Hz”, “120 Hz”.

“RF mode” – Adjusting the transmission mode

The “RF mode” menu item allows you to adjust the transmission mode (see the instruction manual for the Digital 9000 system).

“Display” – Selecting a standard display

The “Display” menu item allows you to select one out of 3 standard displays.



Frequency



Preset



Name

“Lock” – Activating/deactivating the lock mode

Via the “Lock” menu item, you can activate or deactivate the lock mode. For more information on how to activate or deactivate the lock mode, refer to page 11.

“Test tone” – Activating the 1 kHz test tone

Via the “Test tone” menu item, you can activate a 1 kHz test tone. This test tone is transmitted instead of the input signal. You can use this function for level matching your system or for the walk test.

“Reset” – Resetting the factory default settings

Via the “Reset” menu item, you can reset the radio microphone to its factory default settings.

“Information” – Displaying the firmware version and frequency range

Via the “Information” menu item, you can display the firmware version and the transmitter’s frequency range.

Cleaning and maintaining the SKM 9000

CAUTION!

Liquids can damage the electronics of the devices!

Liquids entering the housing of the devices can cause a short-circuit and damage the electronics.

- ▶ Keep all liquids away from the devices.
 - ▶ Do not use any solvents or cleansing agents.
-

- ▶ Remove the rechargeable batteries or batteries before cleaning.
- ▶ Only use a soft, dry cloth to clean the radio microphone.

Cleaning the sound inlet basket of the microphone head

- ▶ Unscrew the upper sound inlet basket from the microphone head by turning it counterclockwise (see diagram).

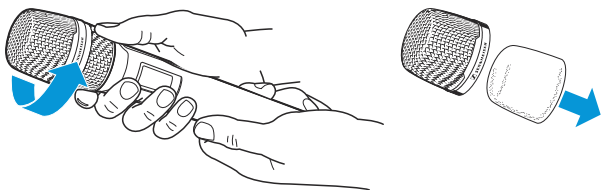

- ▶ Remove the foam insert.

To clean the sound inlet basket:

- Use a slightly damp cloth to clean the upper sound inlet basket from the inside and outside
- or scrub with a brush and rinse with clear water.
- ▶ If necessary, clean the foam insert with a mild detergent or replace the foam insert.
- ▶ Dry the upper sound inlet basket and the foam insert.
- ▶ Reinsert the foam insert.
- ▶ Replace the sound inlet basket on the microphone head and screw it tight.

You should also clean the contact rings of the microphone head from time to time:

- ▶ Wipe the contact rings of the microphone head with a soft, dry cloth.

If a problem occurs ...

Problem	Possible cause	Possible solution
Transmitter cannot be operated, "LOCK" appears on the display panel	Lock mode is activated	Deactivate the lock mode
No operation indication	Batteries are flat or accupack is flat	Replace the batteries or recharge the accupack.
No RF signal at the receiver	Transmitter and receiver are not on the same frequency	Transmitter to the same frequency as the receiver.
	Transmission range is exceeded	Reduce the distance between transmitter and receiving antennas.
	Transmitter's RF signal is deactivated ("RF Mute")	Activate the RF signal.
Audio signal has a high level of background noise or is distorted	Transmitter input gain is adjusted too low/too high	Adjust the input gain (see page 15).

If a problem occurs that is not listed in the above table or if the problem cannot be solved with the proposed solutions, please contact your local Sennheiser partner for assistance.

To find a Sennheiser partner in your country, search at www.sennheiser.com under "Service & Support".

Specifications

System characteristics

Frequency ranges	470 to 798 MHz, divided into 24 MHz booster frequency ranges				
	EM 9046 DRX	TX variant	Booster variant A1–A8		
	470–798 MHz (expandable to 934 MHz)	A1–A4 470– 558 MHz	A1	470–494 MHz	
			A2	494–518 MHz	
			A3	510–534 MHz	
			A4	534–558 MHz	
		A5–A8 550– 638 MHz	A5	550–574 MHz	
			A6	574–598 MHz	
			A7	590–614 MHz	
			A8	614–638 MHz	
	EM 9046 DRX	TX variant	Booster variant B1–B8		
	470–798 MHz (expandable to 934 MHz)	B1–B4 630– 718 MHz	B1	630–654 MHz	
			B2	654–678 MHz	
			B3	670–694 MHz	
B4			694–718 MHz		
B5–B8 710– 798 MHz		B5	710–734 MHz		
		B6	734–758 MHz		
		B7	750–774 MHz		
		B8	774–798 MHz		
Transmission method	digital modulation “HD” mode: without audio data compression “LR” mode: SeDAC (Sennheiser Digital Audio Codec)				
Audio frequency response	80 Hz to 20 kHz (3 dB) with SKM 9000				
Dynamic range	“HD” mode: 112 dB(A) “LR” mode: 101 dB(A)				

Specifications

Latency	Analog Audio Out: 3.2 ms Digital Audio Out: 3 ms (AES/EBU)
THD	"HD" mode: < 0.01% (at 1 kHz) "LR" mode: < 0.03% (at 1 kHz)

Operating conditions

Ambient temperature	-10°C to +50°C
Relative humidity	max. 85% at 40°C (non-condensing)
Protection against dripping and light splashing of liquids	the product must not be exposed to dripping and splashing (IP2X)

Storage and transport conditions

Ambient temperature	-25°C to +70°C
Relative humidity	max. 90% at 40°C
Protection against dripping and light splashing of liquids	the product must not be exposed to dripping and splashing (IP2X)
Shock resistance	as per IEC 68 or EN 60068, T2-27

SKM 9000 characteristics

RF characteristics

Frequency ranges	470 MHz to 798 MHz, divided into 4 ranges: SKM 9000 A1–A4: 470–558 MHz SKM 9000 A5–A8: 550–638 MHz SKM 9000 B1–B4: 630–718 MHz SKM 9000 B5–B8: 710–798 MHz (see also table “System characteristics” on page 19)
Frequency ranges USA	550 MHz to 718 MHz, divided into 2 ranges: SKM 9000 A5–A8: 550–638 MHz SKM 9000 B1–B4: 630–718 MHz
Switching bandwidth	88 MHz
RF output power	“HD” mode: 10 mW rms, 50 mW peak “LR” mode: 25 mW rms, 50 mW peak
Frequency stability	< 5 ppm
Tuneability	in steps of 25 kHz

AF characteristics

Audio gain	adjustable in 3 dB steps from 0 dB to +62 dB (depending on microphone head)
Lower cut-off frequency (–3 dB)	adjustable: 60 Hz, 80 Hz, 100 Hz, 120 Hz

Other characteristics

Operating time	5.5 hrs (with BA 60 accupack)
Power consumption	approx. 1 W
Dimensions	270 x 40 mm (L x Ø)
Weight	approx. 350 g (with BA 60 accupack and ME 9005 microphone head)

In compliance with

Europe	EMC	EN 301489-1/-9
	Radio	EN 300422-1/-2
	Safety	EN 60065
		EN 62311 (SAR)

Approved by

USA

FC Part 74
FCC-ID: DMOSKM9000
limited to 698 MHz

Canada

Industry Canada RSS-123
IC: 2099A-SKM9000
limited to 698 MHz

Brazil

QUANTA BRASIL IMPORTAÇÃO E
EXPOR-TAÇÃO LTDA. 0261-15-7356



(78)98945-536973

EUROBRAS FILM PRODUÇÕES CINEMATO-
GRAFICAS LTDA. 0936-15-7356



(78)98465-470247



Sennheiser electronic GmbH & Co. KG

Am Labor 1, 30900 Wedemark, Germany
www.sennheiser.com

Publ. 06/17, 559419