



# MKH 8090

- Quick Guide
- Kurzanleitung
- Guide rapide
- Guía rápida
- Guía de inicio rápido
- Guia rápido
- Beknopte handleiding
- Krótká instrukcja obsługi
- Snabbguide
- Kort vejledning
- Pikaohje
- Γρήγορος οδηγός
- Kısa Kılavuz
- Краткая инструкция
- 快速指南
- 快速使用指南
- クイックガイド
- 퀵 가이드

**SENNHEISER**

## In the box

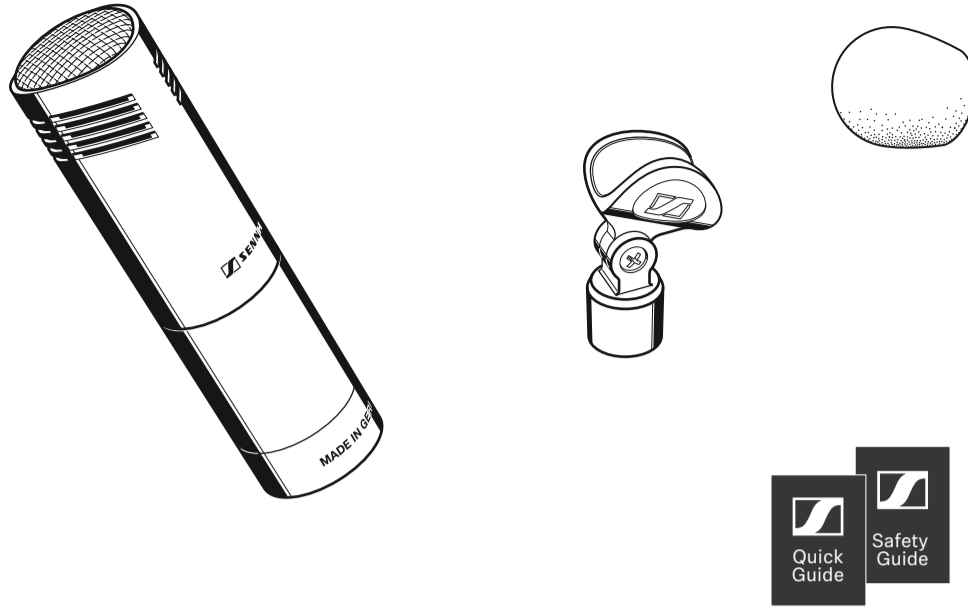

## Overview

- 1 Microphone head
- 2 XLR module

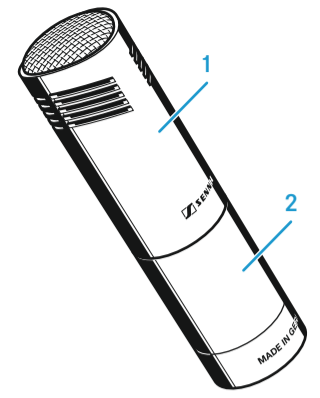

## Setup

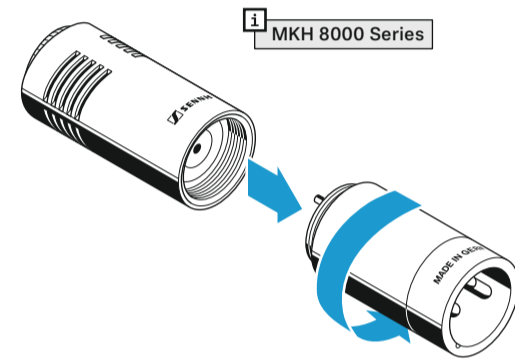
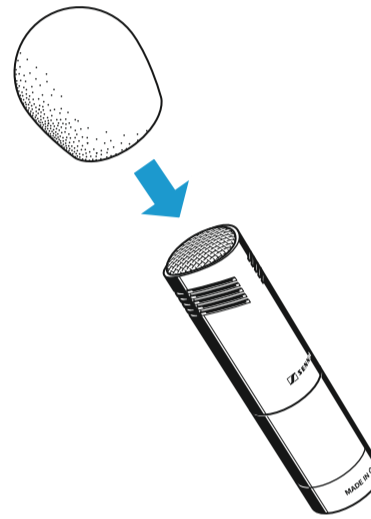
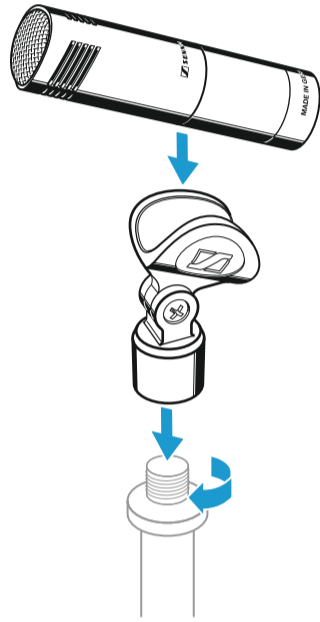

Sennheiser electronic GmbH & Co. KG

Am Labor 1, 30900 Wedemark, Germany  
www.sennheiser.com

Printed in Germany, Publ. 07/23, 581393/A04

## Stereo recording

**Time-of-arrival stereo (AB):**  
(almost) only time-of-arrival differences

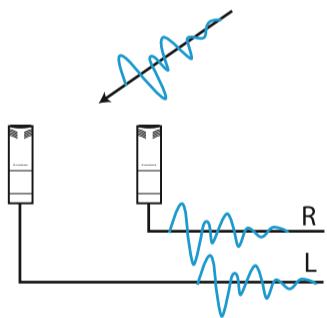

**Intensity stereo (XY):**  
only sound pressure level differences

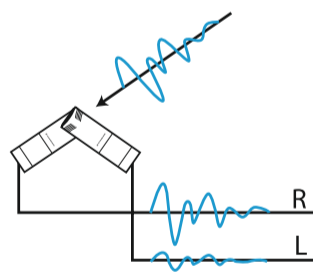

**Equivalence or mixed stereo (here: ORTF):**  
sound pressure level and time-of-arrival differences

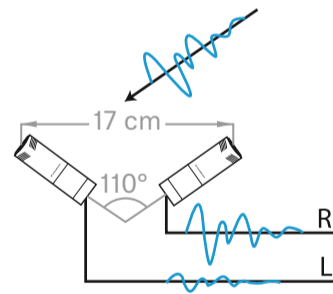

**Baffle stereo (here: OSS):**  
sound pressure level, time-of-arrival and spectral differences with off-axis sound

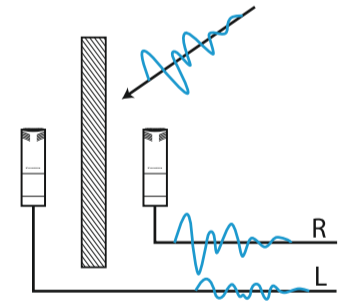

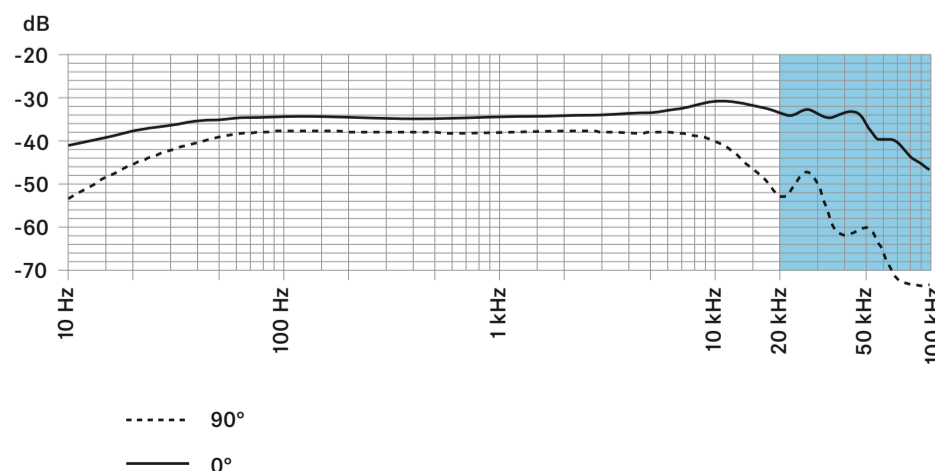
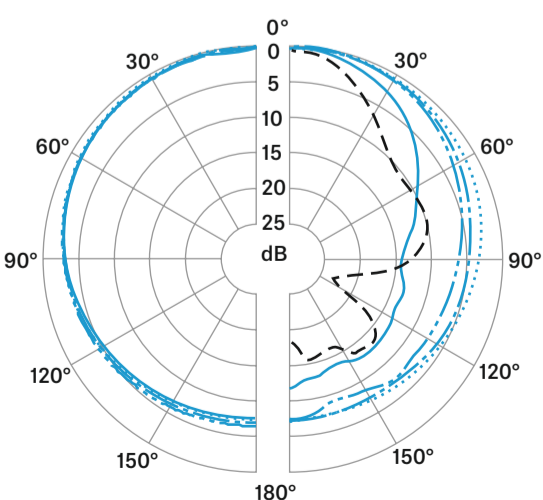

## Polar pattern and frequency response



## Specifications

Pick-up pattern	wide cardioid
Frequency response	30 - 50,000 Hz
Sensitivity	-34 dBV/Pa (31 mV/Pa) with MZF 8000 II -44 dBV/Pa (10 mV/Pa)
Max. SPL	142 dB with MZF 8000 II 142 dB
Equivalent noise level	13 dB(A) 23 dB (CCIR)
Nominal impedance	25 Ω
Min. terminating impedance	4 Ω
Phantom powering	48 V ±4 V (P48, IEC 61938)
Current consumption	3.3 mA
Diameter	approx. 19 mm
Length	approx. 41 mm with MZF 8000 II approx. 75 mm
Weight	approx. 25 g with MZF 8000 II approx. 55 g
Operating temperature	-10 °C to 60 °C

Microphone and accessories overview

audio signal   
mounting accessories 

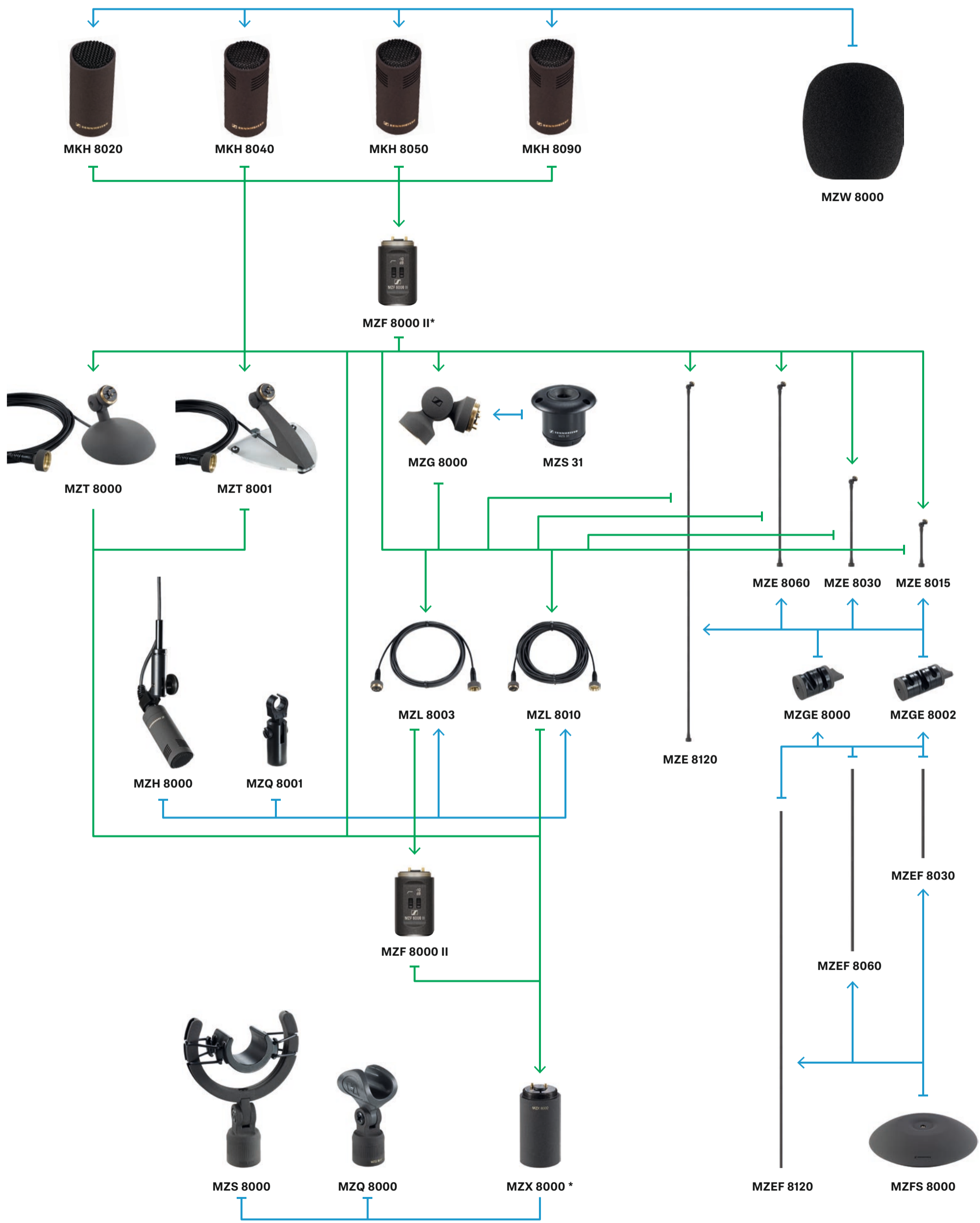

\*Screw filter module MZF 8000 II at suitable place between microphone head and XLR module.