



e 825 S



www.sennheiser.com/download

Quick Guide
 Kurzanleitung
 Guide rapide
 Guida rapida
 Guía de inicio rápido
 Guia rápido
 Beknopte handleiding
 Krótka instrukcja obsługi
 Snabbguide

Kvikstartguide
 Pikaohje
 Γρήγορος οδηγός
 Kısa Kılavuz
 Краткая инструкция
 快速指南
 快速使用指南
 クイックガイド
 퀵 가이드

Sennheiser electronic SE & Co. KG

Am Labor 1, 30900 Wedemark, Germany
www.sennheiser.com

Printed in Germany
Publ. 04/24, 581328/A04

SENNHEISER

Setup

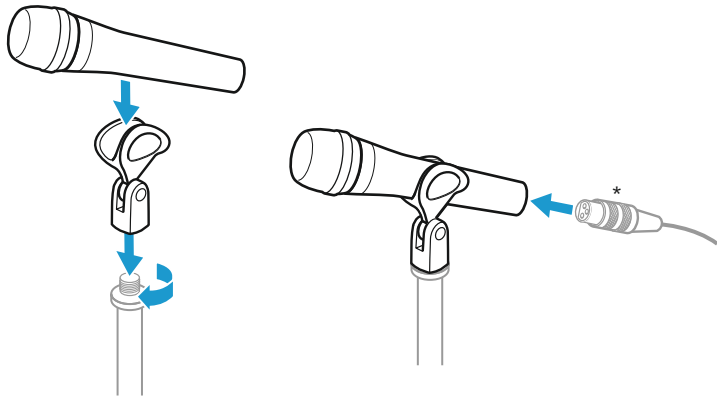

*XLR-3 cable not included

In the box

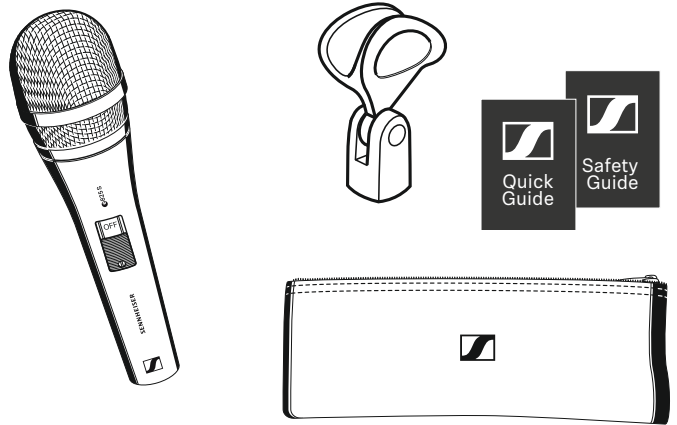

Overview

- 1 Sound inlet basket
- 2 XLR-3 connector
- 3 On/off switch
- 4 Screw

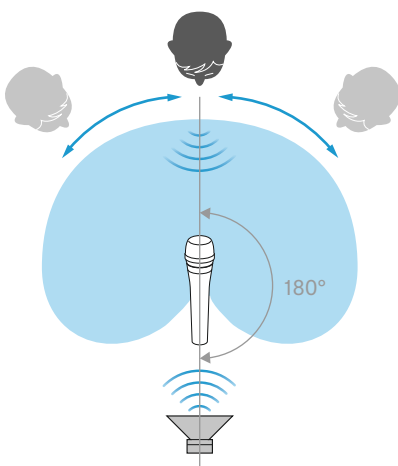
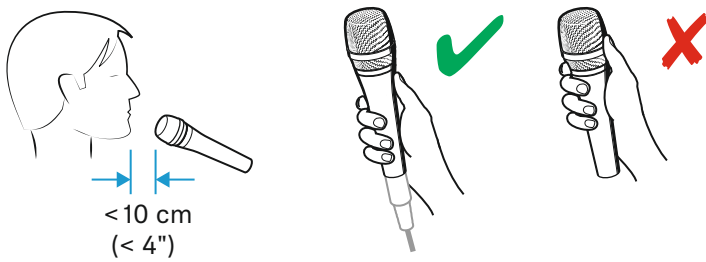
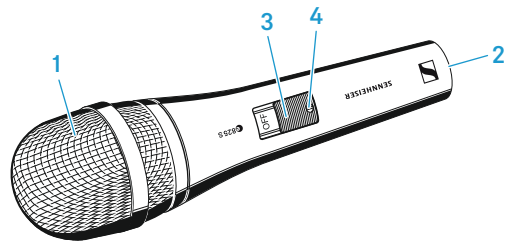

ON/OFF

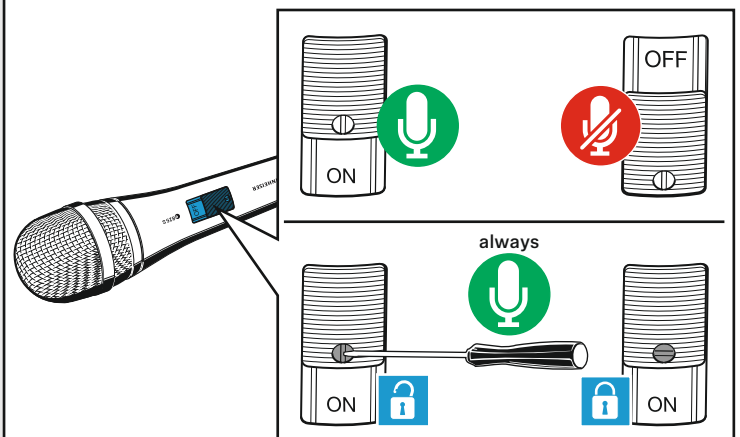

Accessory

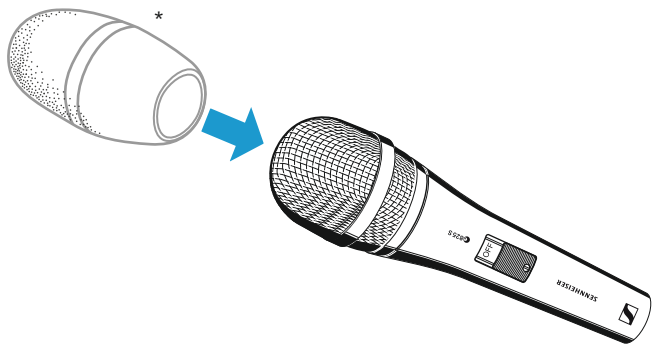

*MZW 4032 not included

Cleaning

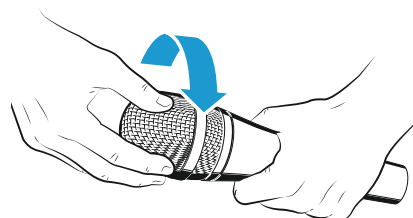
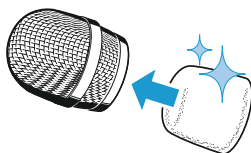
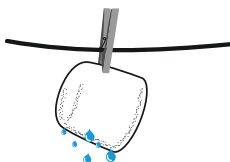
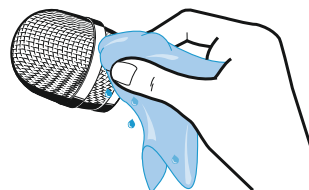
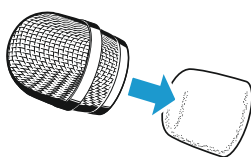
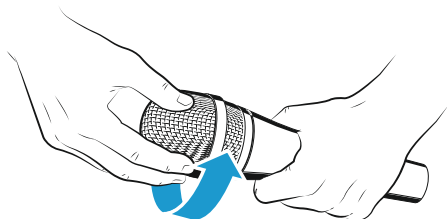

Specifications

Transducer principle	dynamic
Frequency response	80 - 15,000 Hz
Pick-up pattern	cardioid
Sensitivity (free field, at 1 kHz)	1.5 mV/Pa
Nominal impedance (at 1 kHz)	350 Ω
Min. terminating impedance	1 kΩ
Connector	XLR-3
Temperature range	0 °C to +40 °C
Dimensions	∅ 48 x 180 mm
Weight	330 g

Connector assignment

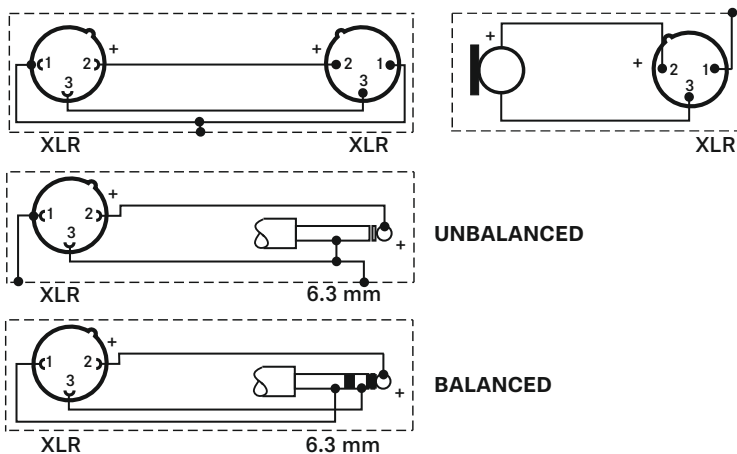

Polar pattern and frequency response

